

## CABINOTTO CABÌ INTERNO A SPALLA

CABÌ WALK-IN CLOSET WITH LOAD-BEARING SIDE INTERIOR

## CABINOTTO CABÌ INTERNO PALÙ

CABÌ WALK-IN CLOSET PALÙ INTERIOR

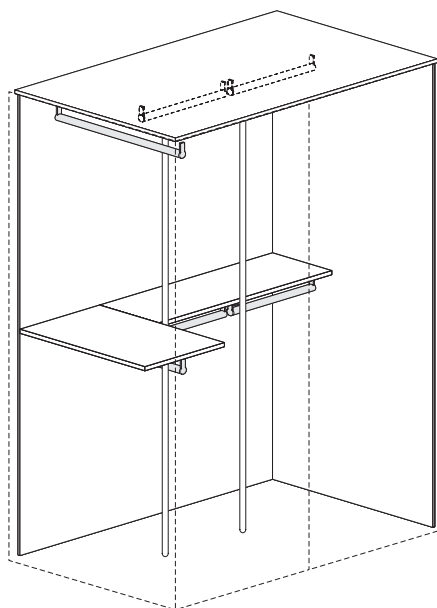
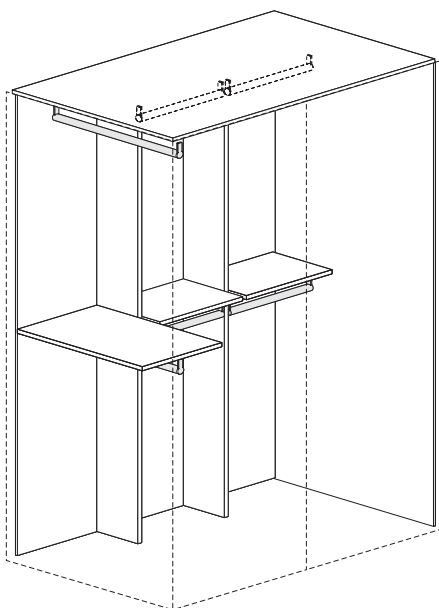

## ALTEZZE

HEIGHTS

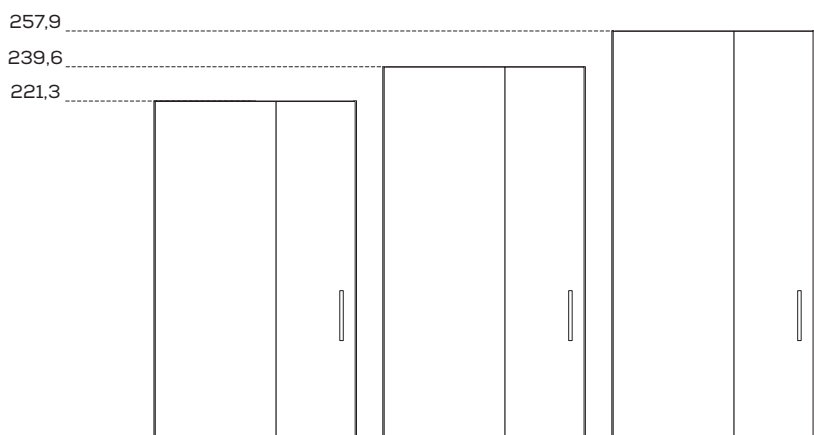

## TIPOLOGIE DI APERTURA

OPENING SYSTEMS

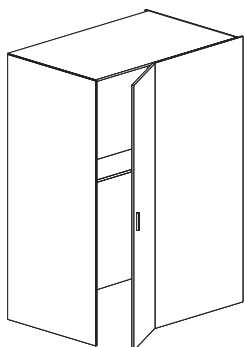

Apertura frontale battente  
(Per cabina L 135,3-165,3 cm)

Hinged front opening  
(For 135,3-165,3 cm-wide closet)

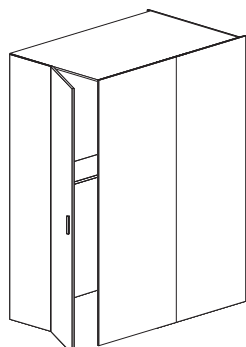

Apertura laterale battente  
(Per cabina L 135,3-165,3 cm)

Hinged side opening  
(For 135,3-165,3 cm-wide closet)

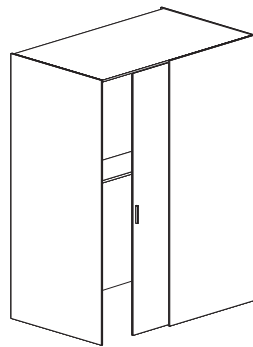

Apertura frontale scorrevole  
(Per cabina L 135,3-165,3-195,3 cm)  
con chiusura Softspace

Sliding front opening  
(For 135,3-165,3-195,3 cm-wide  
closet) with Softspace closing system

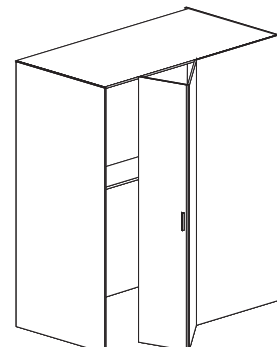

Apertura frontale pieghevole  
(Per cabina L 195,3 cm)

Folding front opening  
(For 195,3 cm-wide closet)

### LARGHEZZE E PROFONDITÀ

WIDTHS AND DEPTHS

#### CABINOTTO CABÌ INTERNO A SPALLA

CABÌ WALK-IN CLOSET WITH LOAD-BEARING SIDE INTERIOR

Cabine apertura frontale battente/pieghevole

Walk-in closets with hinged/folding front opening

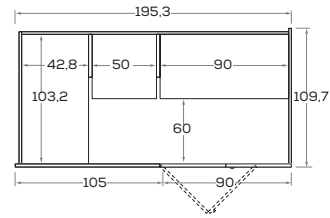
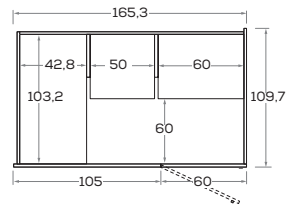
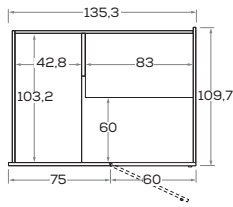

Cabine apertura laterale battente

Walk-in closets with hinged side opening

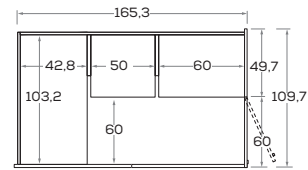
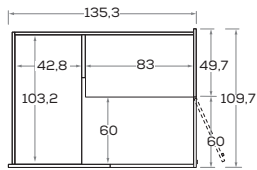

Cabine apertura frontale scorrevole

Walk-in closets with sliding front opening

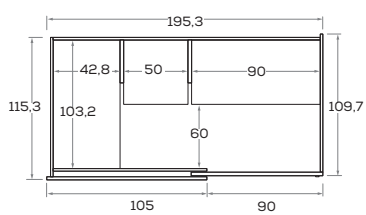
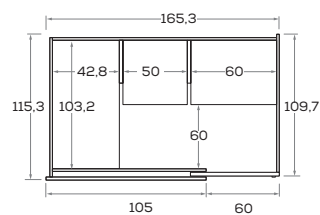
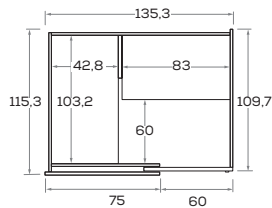

#### CABINOTTO CABÌ INTERNO PALÙ

CABÌ WALK-IN CLOSET PALÙ INTERIOR

Cabine apertura frontale battente/pieghevole

Walk-in closets with hinged/folding front opening

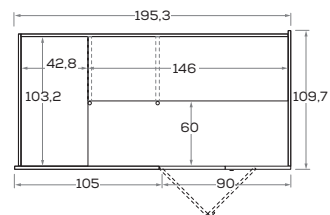
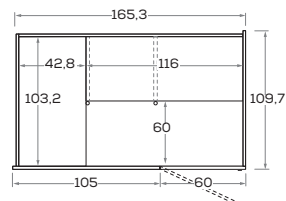
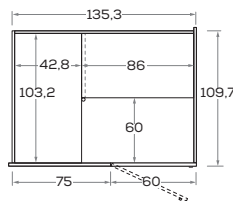

Cabine apertura laterale battente

Walk-in closets with hinged side opening

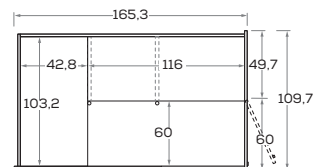
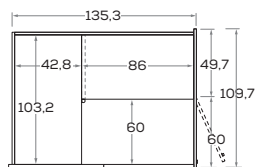

Cabine apertura frontale scorrevole

Walk-in closets with sliding front opening

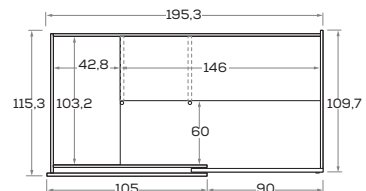
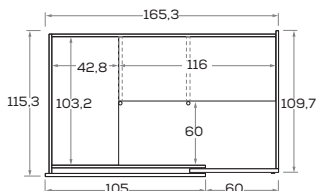
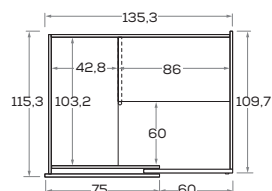

Le informazioni contenute nelle presenti schede tecniche sono indicative. Eventuali differenze con il listino in vigore non costituiscono motivo di contestazione.

The information given in this technical sheet are indicative. Any discrepancies with the price list currently in force cannot be cause for complaint.